

Integrated amplifier and controller electronics for proportional hydraulic valves

- Interface: - analogue
- CANopen or J1939
- Profibus DP
- 24 VDC or 12 VDC
- Electronic card setting via PC (USB)
- Optimisation of characteristic curve

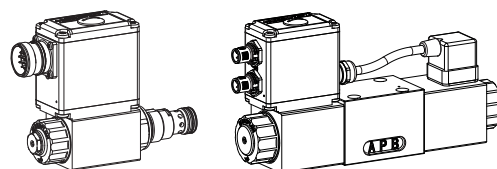

Description

Wandfluh offers proportional valves with integrated, intelligent electronics. With protection class IP67 these valves are suitable for rough ambient conditions. The term “Digital Smart Valve” stands for digital amplifier or controller electronics requiring the smallest space. As a result of the compact construction, Wandfluh is in the position to also offer miniature valves of the nominal size 4 in an optimum, slender design. In addition to this, Wandfluh as the only manufacturer offers proportional screw-in cartridges M22 and M33 with integrated electronics. The electronics are mounted onto a slip-on coil.

Function

The actuation takes place via an analogue interface or a fieldbus interface (CANopen/J1939 or Profibus DP). The parameterisation takes place by means of the free-of-charge parameterisation and diagnosis software “PASO” or via the fieldbus interface.

“PASO” is a Windows program in the flow diagram style, which enables the intuitive adjustment and storing of all variable parameters. The data remain saved in case of a power failure and can also be reproduced and transferred to other DSVs.

As an option, these valves are available with an integrated controller. As feedback value generators sensors with voltage or current outputs can be directly connected. The available controller structures have been optimised for applications with hydraulic actuators.

Application

The „DSV“ electronics are used by Wandfluh exclusively for proportional hydraulic valves. They are factory set and adjusted in order to guarantee the highest valve-to-valve reproducibility. The hydraulic valves have their application where a good valve-to-valve reproducibility, a simple installation, convenient operation and the highest precision are of great importance. The integrated controller relieves the machine control and operates the axis (position, angle, pressure, etc.) in a closed control loop. The applications are in the industrial as well as in the mobile hydraulics for the smooth control of hydraulic actuations.

TYPE CODE

_____ - _____ M E _____ - _____ # _____

Type designation according to type list, (derived from valve designation basic execution)

Example: BVPPM33 - 200

Standard nominal voltage U _N :	12 VDC	G12
	24 VDC	G24

Slip-on coil	Metal housing, square
--------------	-----------------------

Connection execution	Integrated electronics
----------------------	------------------------

Hardware configuration:

Analog command value signal	12-pole	A1	7-pole	D1	(0...+10V factory preset)
Analog command value signal	12-pole	A2	7-pole	D2	(-10...+10V factory preset)
Analog command value signal	12-pole	A3	7-pole	D3	(0...+20mA factory preset)
Analog command value signal	12-pole	A4	7-pole	D4	(4...+20mA factory preset)
CANopen according to DSP-408		C1			
Profibus DP acc. to Fluid Power Technology		P1			
CAN J1939 (on request)		J1			

Functions:

Amplifier	no remark
-----------	-----------

Controller with current feedback value signal (0...20 mA / 4...20 mA)	R1
Controller with voltage feedback value signal (0...10 V)	R2

Sealing material / manual override

Design-Index (Subject to change)

- | | | | | |
|-----------------------------|----------------------------|---------------------------------|--------------------------------|--------------------------|
| Архангельск (8182)63-90-72 | Ижевск (3412)26-03-58 | Магнитогорск (3519)55-03-13 | Пермь (342)205-81-47 | Сургут (3462)77-98-35 |
| Астана (7172)727-132 | Иркутск (395)279-98-46 | Москва (495)268-04-70 | Ростов-на-Дону (863)308-18-15 | Тверь (4822)63-31-35 |
| Астрахань (8512)99-46-04 | Казань (843)206-01-48 | Мурманск (8152)59-64-93 | Рязань (4912)46-61-64 | Томск (3822)98-41-53 |
| Барнаул (3852)73-04-60 | Калининград (4012)72-03-81 | Набережные Челны (8552)20-53-41 | Самара (846)206-03-16 | Тула (4872)74-02-29 |
| Белгород (4722)40-23-64 | Калуга (4842)92-23-67 | Нижний Новгород (831)429-08-12 | Санкт-Петербург (812)309-46-40 | Тюмень (3452)66-21-18 |
| Брянск (4832)59-03-52 | Кемерово (3842)65-04-62 | Новокузнецк (3843)20-46-81 | Саратов (845)249-38-78 | Ульяновск (8422)24-23-59 |
| Владивосток (423)249-28-31 | Киров (8332)68-02-04 | Новосибирск (383)227-86-73 | Севастополь (8692)22-31-93 | Уфа (347)229-48-12 |
| Волгоград (844)278-03-48 | Краснодар (861)203-40-90 | Омск (3812)21-46-40 | Симферополь (3652)67-13-56 | Хабаровск (4212)92-98-04 |
| Вологда (8172)26-41-59 | Красноярск (391)204-63-61 | Орел (4862)44-53-42 | Сочи (862)225-72-31 | Челябинск (351)202-03-61 |
| Воронеж (473)204-51-73 | Курск (4712)77-13-04 | Оренбург (3532)37-68-04 | Ставрополь (8652)20-65-13 | Череповец (8202)49-02-64 |
| Екатеринбург (343)384-55-89 | Липецк (4742)52-20-81 | Пенза (8412)22-31-16 | | Ярославль (4852)69-52-93 |
| Иваново (4932)77-34-06 | | | | |

Electrical SPECIFICATIONS

Protection class	IP 67 acc. to EN 60 529 With suitable mating connector and closed electronics housing cover	Input resistance	Voltage input >18 kΩ Load for current input = 250 Ω
Device receptacle (male) Analog interface	M23, 12-pole or Connector DIN EN175201 - 804, 7-pole	Command value signal CANopen/J1939 interface	via CANopen / J1939 Two wire lead acc. to ISO 11898 Differential signal transmission
Device receptacle (male) Supply Fieldbus interface	M12, 4-pole	Command value signal Profibus	via Profibus Shielded, twisted wire Differential signal transmission
Mating connector (female)	Plug M23, 12-pole or Plug DIN EN175201 - 804, 7-pole or Plug M12, 4-pole (not incl. in delivery)	Feedback value signal: (controller only)	Differential input not galvanically separated, for earth potential difference up to 1,5V • Type R1 4...+20 mA / 0...+20 mA • Type R2 0...+10V / -10...+10V Resolution ±12 bit
Device receptacle (female) Sensor (controller only)	M12, 5-pole	Bustopologie Fieldbus interface	Line
Mating connector (male) Sensor (controller only)	M12, 5-pole (not incl. in delivery)	Separation of potential Fieldbus interface	CANopen / Profibus to DSV 500 VDC
Device receptacle (male) CANopen / J1939	M12, 5-pole (according to DRP 303-1)	Digital inputs (analog interface only with M23 connector, 12-pole)	Switching level high 6...30 VDC Switching level low 0...1 VDC Utilisable as frequency input (frequencies 0...5 kHz) and as PWM-input (automatic frequency recognition)
Mating connector (female) CANopen / J1939	Plug M12, 5-pole (not incl. in delivery)	Digital output (analog interface only with M23 connector, 12-pole)	Low-Side-Switch: $U_{max} = 40$ VDC $I_{max} = -700$ mA
Device receptacle (female) Profibus	M12, 5-pole, B coded (according to IEC 947-5-2)	Ramps adjustable	0...500 s
Mating connector (male) Profibus	Plug M12, 5-pole, B coded (not incl. in delivery)	Temperature drift	<1% at $\Delta T = 40^\circ C$
Voltage range: • 24 VDC • 12 VDC	21...30VDC 10,5...15VDC	Parameterisation only)	via USB or CANopen / J1939 (CANopen / J1939 or Profibus (Profibus only)
Ripple on supply voltage	<10%	Interface	USB (Mini B) for parameterisation with «PASO» under the closing screw of the housing cover factory preset
Fuse	Low	EMC Immunity Emission	EN 61 000-6-2 EN 61 000-6-4
Stabilised output voltage	10 VDC (with version 24 VDC) 8 VDC (with version 12 VDC) max. load 10 mA		
Current consumption: • No load current • 35 mm square size solenoid • 45 mm square size solenoid • Maximum current	approx. 40 mA $I_{max} = 1000$ mA (with version 24 VDC) $I_{max} = 2000$ mA (with version 12 VDC) $I_{max} = 1200$ mA (with version 24 VDC) $I_{max} = 2400$ mA (with version 12 VDC) $I_{max} = 1534$ mA (with version 24 VDC) $I_{max} = 2557$ mA (with version 12 VDC)		
Command value signal: Analog interface	Input voltage/current and signal range are adjustable by software. Diff. inputs not galvanically separated, for ground potential differences up to 1,5V 4...+20 mA / 0...+20 mA 0...+10V (1- or 2-solenoid valve) -10...+10V (only 2-solenoid valve) Resolution +/-12 bit		

DIMENSIONS

Amplifier with analog interface, plug 12-pole

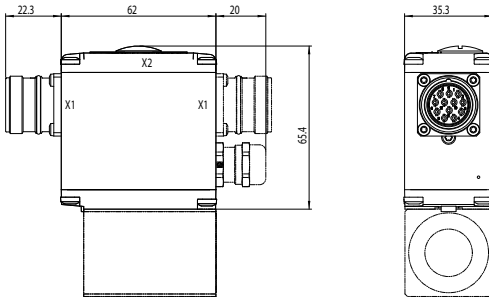

Amplifier with analog interface, plug 7-pole

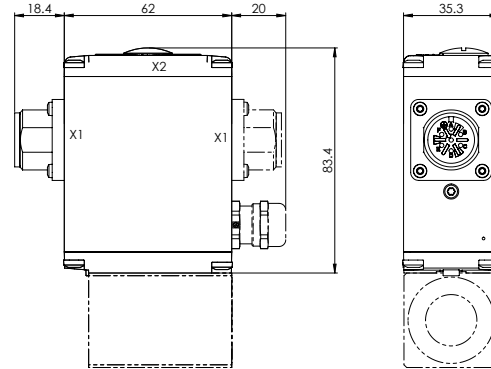

Amplifier with CANopen / J1939 interface

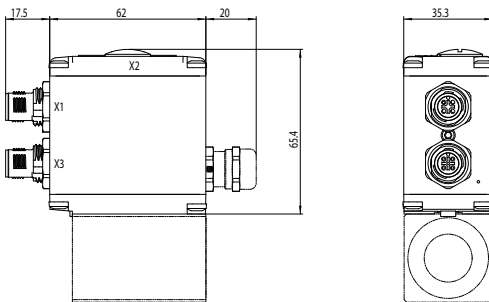

Amplifier with Profibus interface

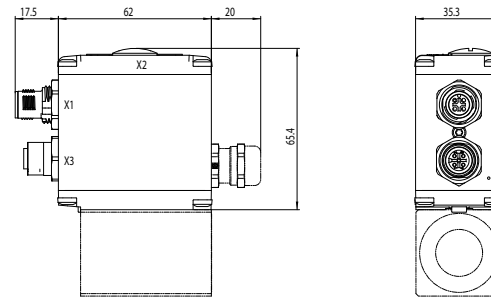

Controller with analog interface, plug 12-pole

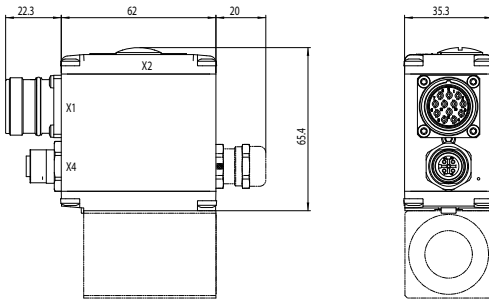

Controller with analog interface, plug 7-pole

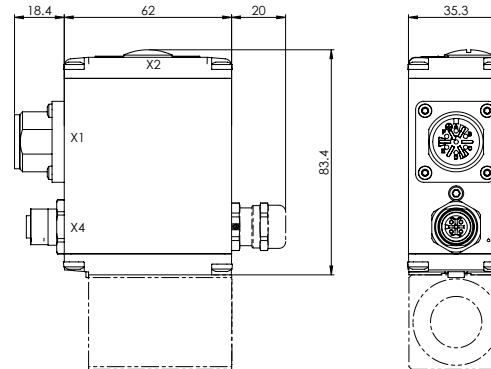

Controller with CANopen / J1939 interface

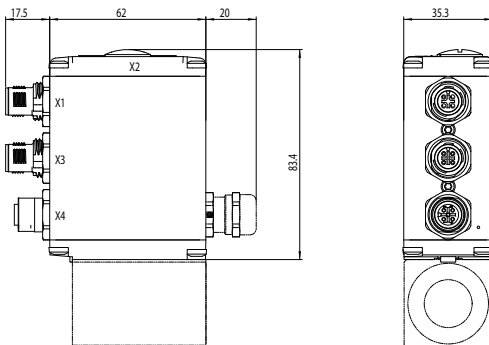

Controller with Profibus interface

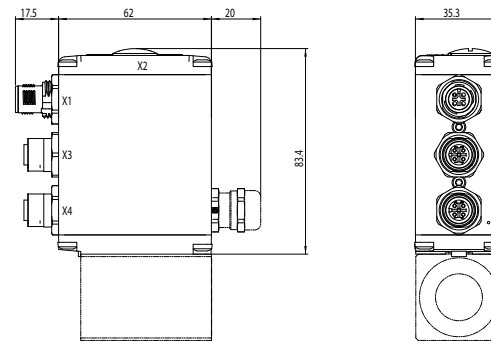



CONNECTOR WIRING DIAGRAM

X1	Analog interface (Main)
Device receptacle	M23, 12 pole male
	1 = Supply voltage + 2 = Supply voltage 0 VDC 3 = Stabilised output voltage 4 = Command value signal voltage + 5 = Command value signal voltage - 6 = Command value signal current + 7 = Command value signal current - 8 = Reserved for extensions 9 = Reserved for extensions 10 = Enable signal (Digital input) 11 = Error signal (Digital output) 12 = Chassis
Command value signal voltage (PIN 4/5) resp. current (PIN 6/7) are selected with parameterisation and diagnostics software PASO.	

X1	Fieldbus interface (Main)
Device receptacle	M12, 4 pole male
	1 = Supply voltage + 2 = Reserved for extensions 3 = Supply voltage 0 VDC 4 = Chassis

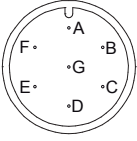
X2	Parameterisation interface
USB, Mini B	Under the screw plug of the housing cover
	Factory set

X1	Analog interface (Main) Connector DIN EN 175201 - 804
Device receptacle	7 pole male
	A = Supply voltage + B = Supply voltage 0 VDC C = Not connected D = Command value signal + E = Command value signal - F = Not connected G = Chassis
Command value signal: current (D3/D4) or voltage (D1/D2) to specify when placing the order	

X3	Profibus interface according to IEC 947-5-2
Device receptacle	M12, 5 pole female B-coded
	1 = VP 2 = Rx/D / Tx/D - N 3 = DGND 4 = Rx/D / Tx/D - P 5 = Shield

X3	CANopen interface according to DRP 303-1
Device receptacle	M12, 5 pole male
	1 = Not connected 2 = Not connected 3 = CAN Gnd 4 = CAN High 5 = CAN Low

X4 (controller only)	Feedback value interface (sensor)
Device receptacle	M12, 5 pole female
	1 = Supply voltage (output) + 2 = Feedback value signal + 3 = Supply voltage 0 VDC 4 = Not connected 5 = Stabilised output voltage
Feedback value signal: current (R1) or voltage (R2) to specify when placing the order	

Note! The mating connector is not included in the delivery

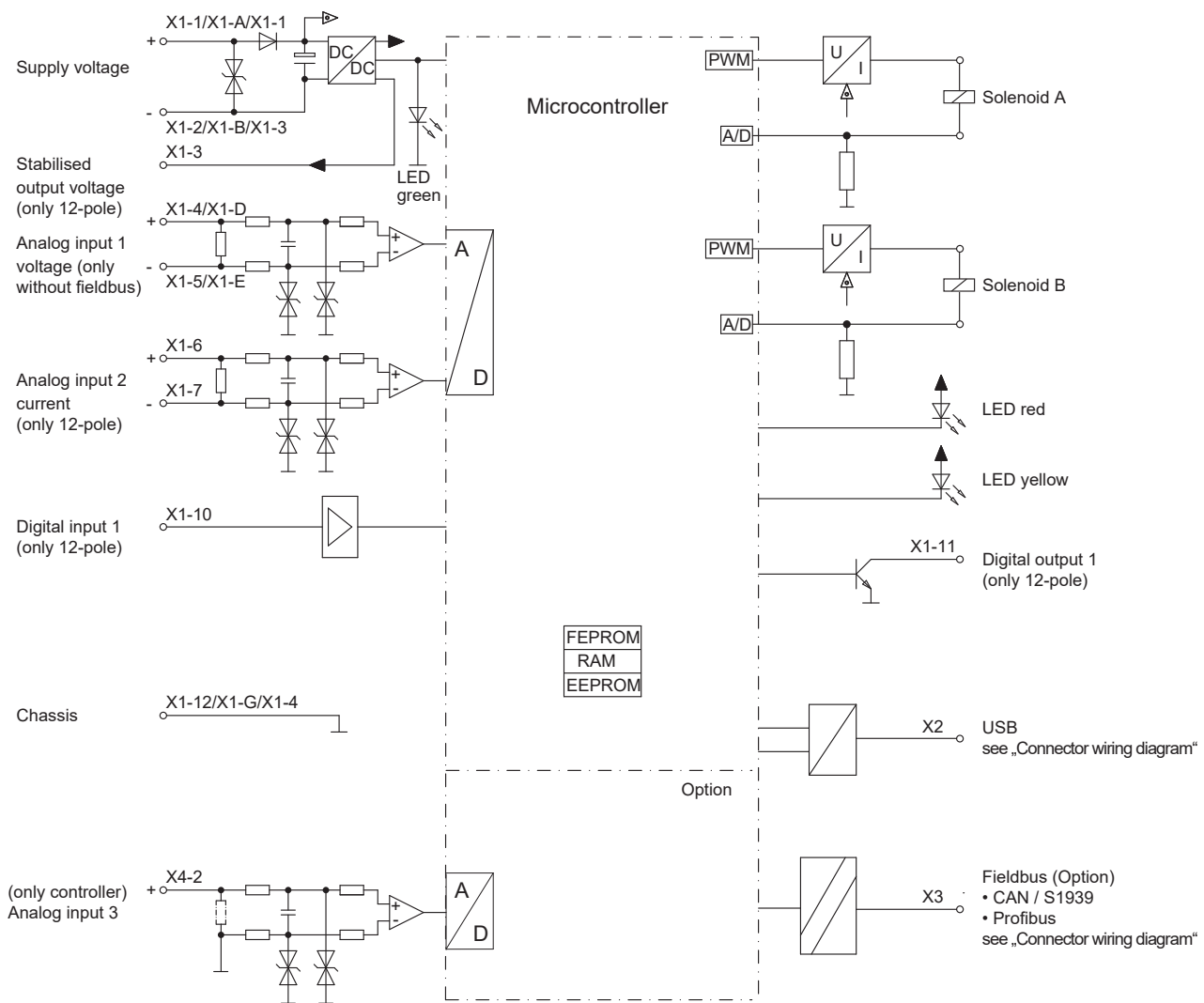

BLOCK DIAGRAM

Configuration analog inputs

Type designation	Analog input 1	Analog input 2	Analog input 3
..A1..	Voltage	Current	
..A2..	Voltage	Current	
..A3..	Voltage	Current	
..A4..	Voltage	Current	
..D1..	Voltage	--	
..D2..	Voltage	--	
..D3..	Current	--	
..D4..	Current	--	
..C1..	--	--	
..P1..	--	--	
..J1..	--	--	
..R1..			Current
..R2..			Voltage

EXAMPLE OF CONNECTION
Connection of the supply voltage

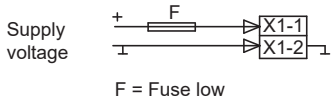
with 12-pole connector



with 7-pole connector

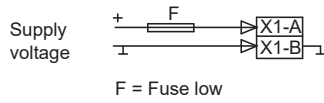

with fieldbus interface

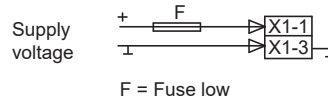
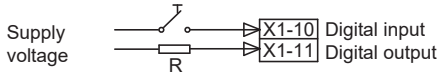
Connection of the digital inputs / outputs (only with 12-pole connector)

R = Consumer resistance for max. current 0,7 A

Connection command value with potentiometer (not differential)

with 12-pole connector

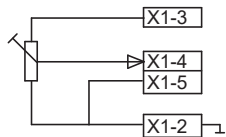

with 7-pole connector

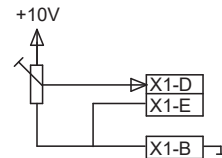
Connection with external command value generator (voltage differential)*

with 12-pole connector

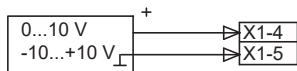

with 7-pole connector

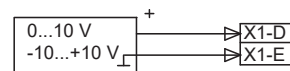
Connection with external command value generator (voltage differential)*

with 12-pole connector

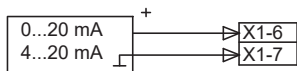

with 7-pole connector

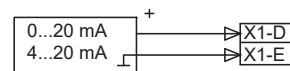

* Ground potential difference between 0V-GND of the external command value generator and 0V-GND of the DSV electronics max. 1.5V. If required, connect the negative input X1-5 or X1-7 with 0V X1-2.

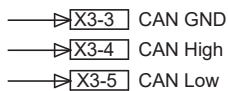
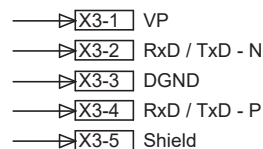
Connection CANopen/J1939

Connection Profibus

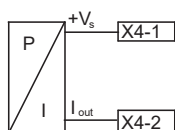
Connection voltage or current feedback value of a pressure sensor

2 conductor

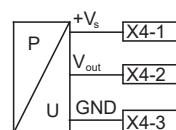

3 conductor



Amplifier electronics

CONSTRUCTION

General

- The „DSV“ electronics is an integral part of the valve.
- All inputs and outputs are to be contacted via the device receptacle.
- Under the closing screw of the housing cover there is a USB - interface, through which with the menu-controlled Windows program „PASO“ the parameterisation and diagnostics can be carried out.
- At the factory the „DSV“ electronics are adapted to the valve, so that, as a rule, no intervention of the user is necessary.

Fieldbus

- The „DSV“ electronics is an integral part of the valve.
- The fieldbus is to be contacted through the corresponding device receptacle.
- CAN open resp. Profibus DP is used as transmission protocol.
- The characteristics and functions of the „DSV“ electronics are described through the device profile DSP-408 „Device Profile Fluid Power Technology“. A detailed description can be found on our website (see Set-up instructions).
- With the fieldbus the „DSV“ electronics can be controlled and parameterised.
- The utilisation of J1939 has to be jointly specified by the customer and Wandfluh.

DESCRIPTION OF THE FUNCTION

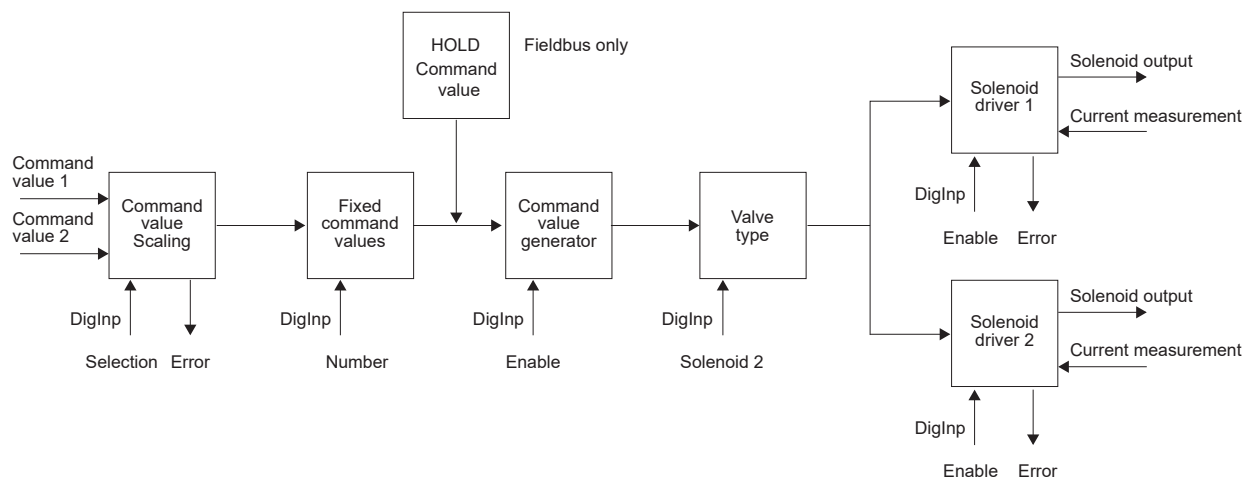

Command value scaling

The command value can be applied as a voltage, current or digital signal, or via fieldbus. For every command value, the input utilised can be selected. The scaling takes place via the parameters „Interface“ and „Reference“. Furthermore every command value can be monitored for a cable break (except for digital signal). For every command value a dead band can also be set. Optionally one can operate with two command values. The characteristic of these command values can be adjusted.

Fixed command values

- One fixed command value is available, which can be selected via a digital input (only DSV electronics with analog interface and 12-pole connector).

Command value generator

For each solenoid output two linear ramps for up and down are available which can be adjusted separately.

HOLD command value (fieldbus option only)

If via Profibus DP the device is put into the „HOLD“ condition, the respective command value is activated.

Valve type

Here the mode of operation mode is set.

Mode of operation „Command value unipolar (1-sol)“

Dependent on a unipolar command value (voltage, current), the solenoid is driven (e.g. 0...10V correspond to 0...100 % command value, 0...100 % command value correspond to I_{min} ... I_{max} solenoid driver 1).

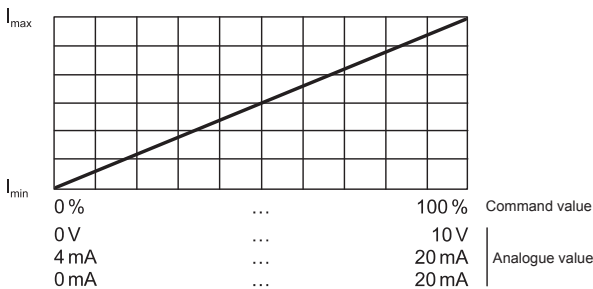

Mode of operation „Command value unipolar (2-sol)“

Dependent on a unipolar command value signal (voltage, current), according to the signal level one of the two solenoids is driven. The switching threshold between the two solenoids as standard is in the middle of the values range of the command value signal (e.g. 0...10V correspond to -100...+100 % command value, -100...0 % command value correspond to I_{min} ... I_{max} solenoid driver 2, 0...+100 % command value correspond to I_{min} ... I_{max} solenoid driver 1).

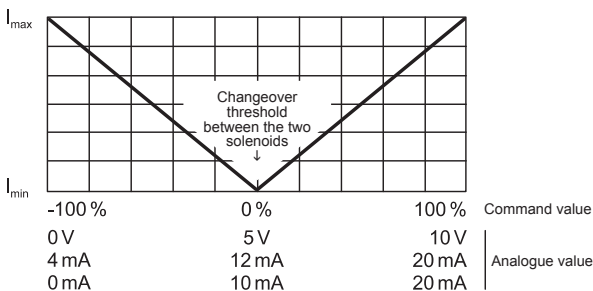

Mode of operation „Command value bipolar (2-sol)“

Dependent on a bipolar command value signal (voltage), according to the signal level one of the two solenoids is driven. The switching threshold between the two solenoids as standard is at 0V (e.g. -10...+10V correspond to -100...+100 % command value, -100...0 % command value correspond to I_{min} ... I_{max} solenoid driver 2, 0...+100 % command value correspond to I_{min} ... I_{max} solenoid driver 1).

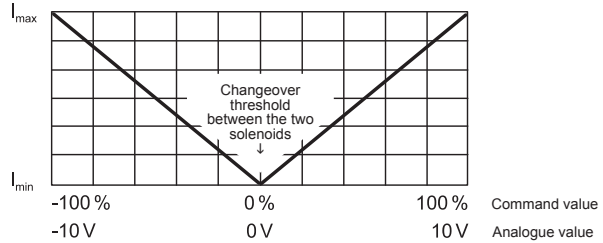

Mode of operation „Command value unipolar (2-sol with DigInp)“

Dependent on a unipolar command value signal (voltage, current), the solenoid is driven by solenoid driver 1, when the selected digital input is „not activated“, resp. the solenoid by the solenoid driver 2, when the selected digital input is „activated“ (e.g. 0...10V correspond to 0...100 % command value, 0...100 % command value correspond to I_{min} ... I_{max} solenoid driver 1 or 2).

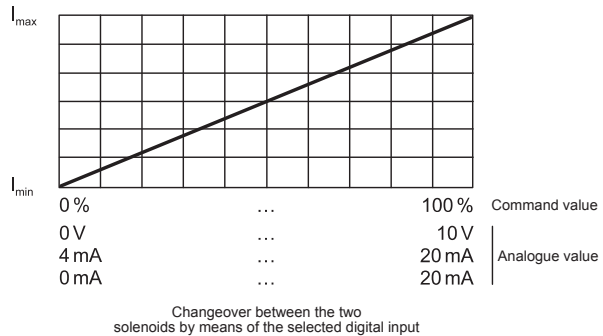

Signal recording

The DSV electronics has a signal recording function. This, by means of PASO, enables the recording of various system signals, such as command value, solenoid currents, etc., which can be represented on a common time axis.

Solenoid driver

Two Pulse-Width-Modulated current outputs are available. To each output, a dither signal is superimposed, whereas dither frequency and dither level can be adjusted separately. For each output, the minimum (I_{min}) and maximum (I_{max}) current can be adjusted separately. The solenoid outputs can also be configured as switching outputs. Therewith for each output a power reduction can be adjusted separately.

Optimisation of characteristic curve

A characteristic curve adjustable per solenoid „Command value input – solenoid current output“ enables an optimised (e.g., linearised) characteristic of the hydraulic system.

Controller electronics

CONSTRUCTION

General

- The „DSV“ electronics is an integral part of the valve.
- All inputs and outputs are to be contacted via the device receptacle.
- Under the closing screw of the housing cover there is a USB - interface, through which with the menu-controlled Windows program „PASO“ the parameterisation and diagnostics can be carried out.
- At the factory the “DSV” electronics are adapted to the valve, so that, as a rule, no intervention of the user is necessary.

Fieldbus

- The fieldbus is to be contacted through the corresponding device receptacle.
- CANopen resp. Profibus DP is used as transmission protocol.
- The characteristics and functions of the „DSV“ electronics are described through the device profile DSP-408 „Device Profile Fluid Power Technology“. A detailed description can be found on our website (see set-up instructions).
- Via the fieldbus, the DSV electronics can be controlled and parameterised.
- The utilisation of J1939 has to be jointly specified by the customer and Wandfluh.

DESCRIPTION OF THE FUNCTION

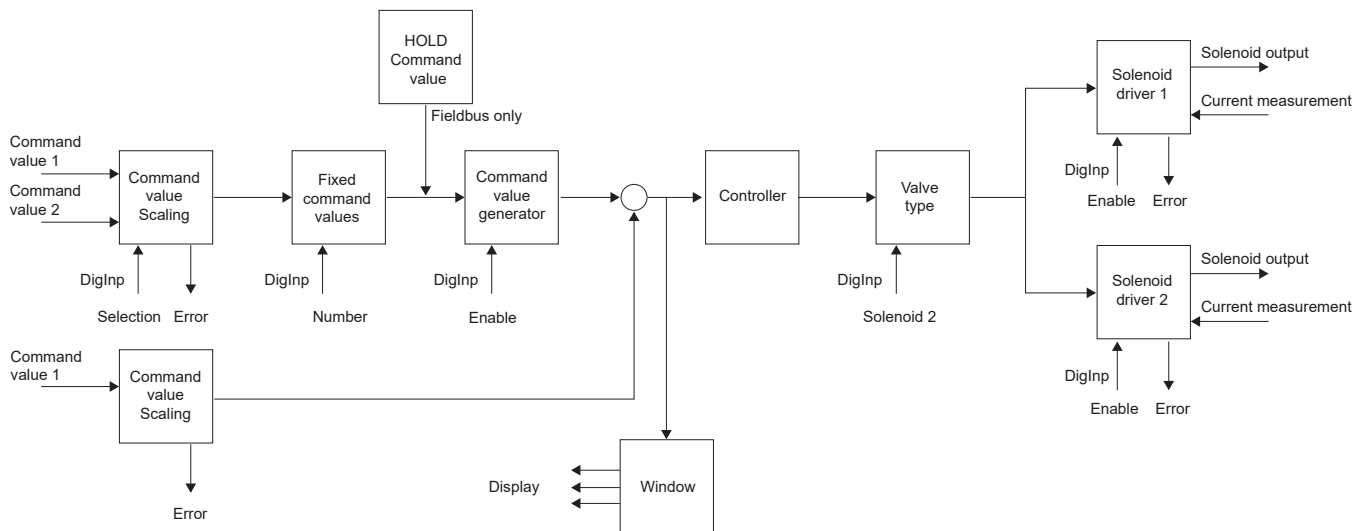

Command value scaling

The command value can be applied via the fieldbus or as a voltage, current, digital, frequency or PWM signal. For every command value, the input utilised can be selected. The scaling takes place via the parameters „Interface“ and „Reference“. Furthermore every command value can be monitored for a cable break (except for digital signal). For every command value a dead band can also be set. Optionally one can operate with two command values. The characteristic of these command values can be adjusted.

Fixed command values

One fixed command value is available, which can be selected via a digital input (only DSV electronics with analog interface and 12-pole connector).

Command value generator

With the Open-Loop-Controller modes, for each solenoid output two linear ramps for up and down are available which can be adjusted separately. With the Closed-Loop-Controller modes, a positive and a negative traversing speed is available.

HOLD command value (fieldbus option only)

If via Profibus DP the device is put into the “HOLD” condition, the respective command value is activated.

Feedback value scaling

The feedback value can be applied as voltage, current, frequency or PWM signal. For the feedback value, the input utilised can be selected. The scaling takes place via the parameters „Interface“ and „Reference“. Furthermore the feedback value can be monitored for a cable break.

Windows

A target, tracking error and magnetic stop window are available. The threshold and delay time can be set for each window.

Controller

The DSV controller module has a controller circuit. This is built up as PID controller. The following controller modes can be selected:

Controller mode Pressure/flow valve control

Control of a pressure relief, pressure reducing, throttle or flow control valve in open control circuit (without feedback value signal). The number of solenoids that can be controlled depends on the selected operating mode.

Controller mode Pressure/flow valve control (1-Sol)»

Actuation of one solenoid pressure relief, pressure reducing, throttle, or flow control valve in closed-loop control circuit (with feedback value signal). Only one solenoid can be controlled with it (corresponds to the magnet driver 1).

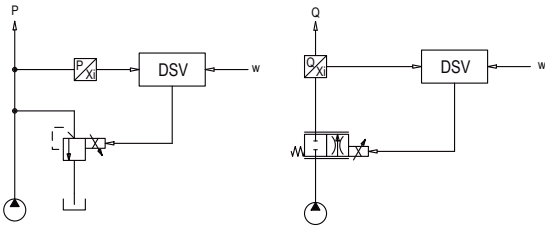
Controller mode „Pressure control (2-Sol)“

Control of two 1 solenoid throttle valves in closed position Control loop (with feedback value signal) as pressure reducing control. The one throttle valve serves as a loading valve and the other as a unloading valve. The loading valve corresponds to the solenoid driver 1, the unloading valve corresponds to the solenoid driver 2.

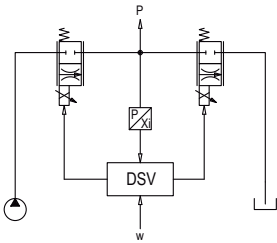
Controller mode „Axis position controlled“

Control of a spool valve in the open control circuit (without feedback value signal). The number of solenoids to be controlled depends on the selected operating mode.

Control mode „Axis position controlled (2-Sol)“

Control of a two solenoid spool valve in closed position control loop (with feedback value signal). Two solenoids can be used with it.

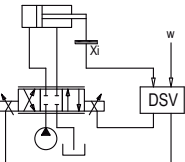
Controller mode „Speed control (2-Sol)“

Control of a two solenoid spool, throttle, or flow control valve in closed control loop (with feedback value signal). Two solenoid can be used with it.

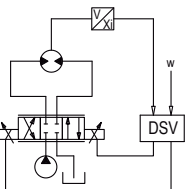
Valve type

The operating mode is set here for the open loop controller modes. It is also possible to select whether proportional or switching solenoids are to be controlled.

Solenoid driver

Two Pulse-Width-Modulated current outputs are available. To each output, a dither signal is superimposed, whereas dither frequency and dither level can be adjusted separately. For each output, the minimum (I_{min}) and maximum (I_{max}) current can be adjusted separately. The solenoid outputs can also be configured as switching outputs. There-with for each output a power reduction can be adjusted separately.

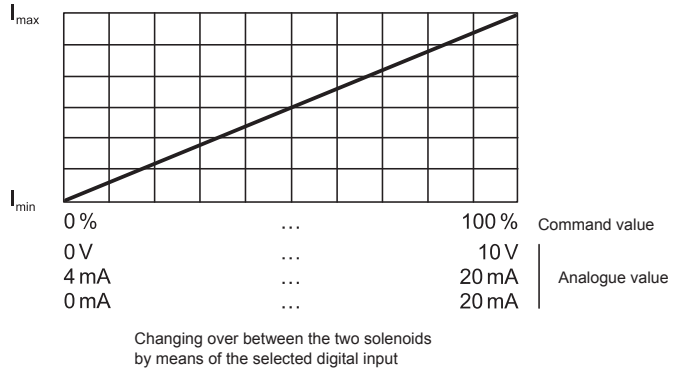
Signal recording

The DSV controller module has a signal recording function. This, by means of PASO, enables the recording of various system signals, such as command value, solenoid currents, etc., which can be represented on a common time axis.

Optimisation of characteristic curve

A characteristic curve adjustable per solenoid „Command value input – solenoid current output“ enables an optimised (e.g., linearised) characteristic of the hydraulic system.

Архангельск (8182)63-90-72
 Астана (7172)727-132
 Астрахань (8512)99-46-04
 Барнаул (3852)73-04-60
 Белгород (4722)40-23-64
 Брянск (4832)59-03-52
 Владивосток (423)249-28-31
 Волгоград (844)278-03-48
 Вологда (8172)26-41-59
 Воронеж (473)204-51-73
 Екатеринбург (343)384-55-89
 Иваново (4932)77-34-06

Ижевск (3412)26-03-58
 Иркутск (395)279-98-46
 Казань (843)206-01-48
 Калининград (4012)72-03-81
 Калуга (4842)92-23-67
 Кемерово (3842)65-04-62
 Киров (8332)68-02-04
 Краснодар (861)203-40-90
 Красноярск (391)204-63-61
 Курск (4712)77-13-04
 Липецк (4742)52-20-81

Магнитогорск (3519)55-03-13
 Москва (495)268-04-70
 Мурманск (8152)59-64-93
 Набережные Челны (8552)20-53-41
 Нижний Новгород (831)429-08-12
 Новокузнецк (3843)20-46-81
 Новосибирск (383)227-86-73
 Омск (3812)21-46-40
 Орел (4862)44-53-42
 Оренбург (3532)37-68-04
 Пенза (8412)22-31-16

Пермь (342)205-81-47
 Ростов-на-Дону (863)308-18-15
 Рязань (4912)46-61-64
 Самара (846)206-03-16
 Санкт-Петербург (812)309-46-40
 Саратов (845)249-38-78
 Севастополь (8692)22-31-93
 Симферополь (3652)67-13-56
 Смоленск (4812)29-41-54
 Сочи (862)225-72-31
 Ставрополь (8652)20-65-13

Сургут (3462)77-98-35
 Тверь (4822)63-31-35
 Томск (3822)98-41-53
 Тула (4872)74-02-29
 Тюмень (3452)66-21-18
 Ульяновск (8422)24-23-59
 Уфа (347)229-48-12
 Хабаровск (4212)92-98-04
 Челябинск (351)202-03-61
 Череповец (8202)49-02-64
 Ярославль (4852)69-52-93

Киргизия (996)312-96-26-47

Россия (495)268-04-70

Казахстан (772)734-952-31